

:DSL



DSL230L - (AU02610)
DSL024L - (AU02624)

Scheda lampeggio LED
ISTRUZIONI PER L'INSTALLAZIONE

LED flashlight board
INSTRUCTIONS FOR INSTALLATIONS

2

DSL230L

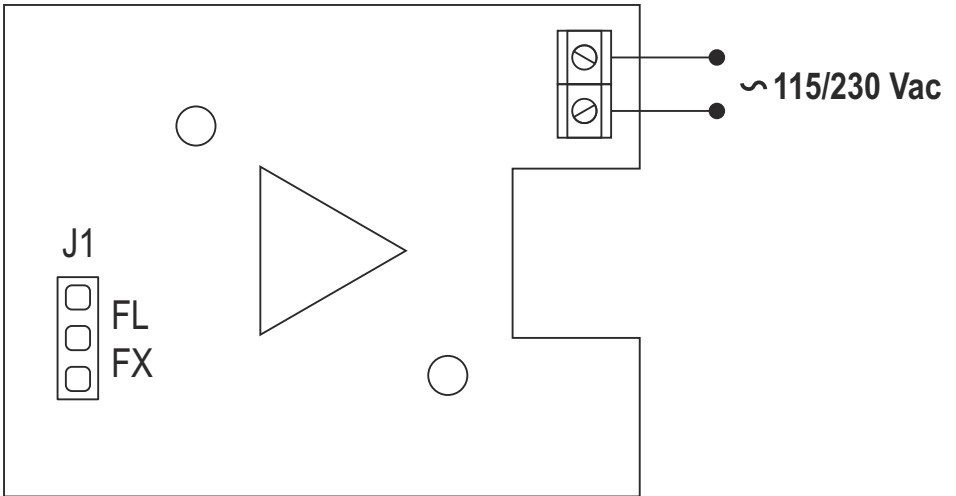
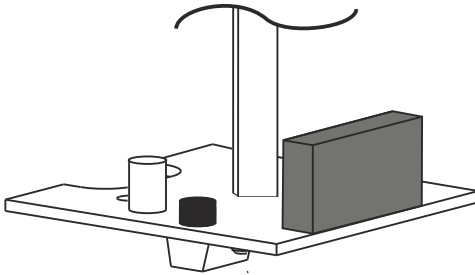



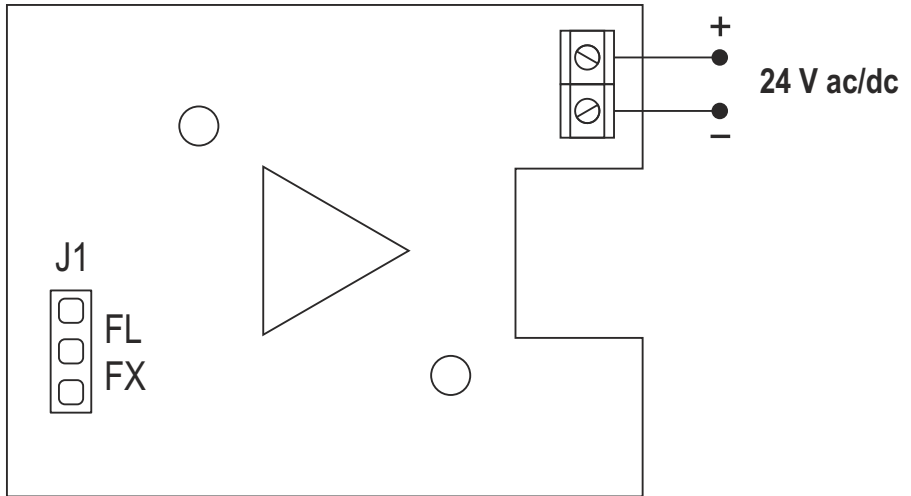
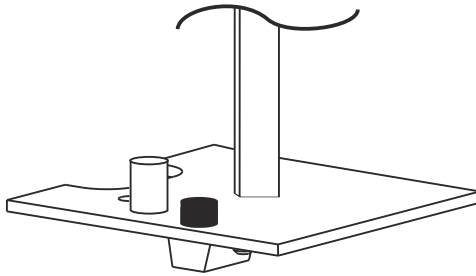



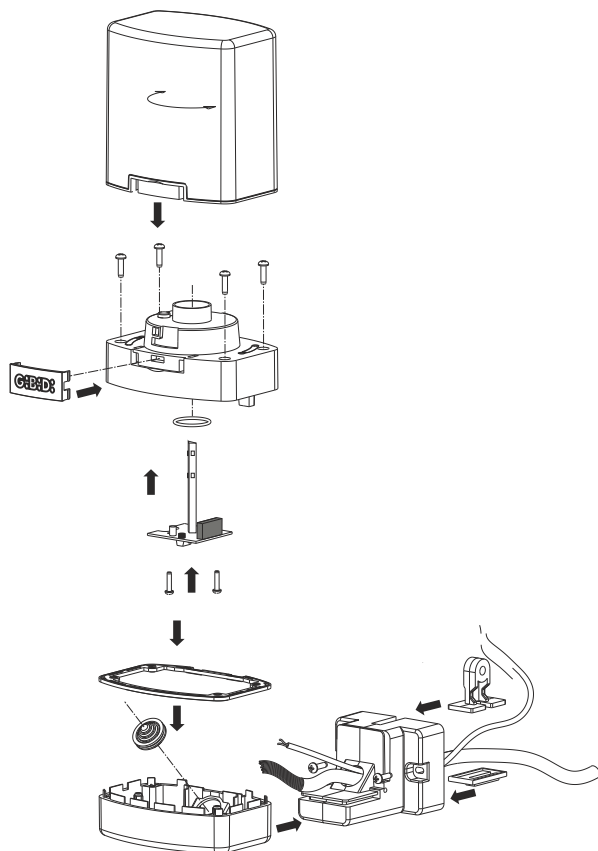

J1	OUT
	2/sec.



J1	OUT
	2/sec.



	DSL230L (AU02610)	DSL024L (AU02624)
	220-230 Vac 50/60 Hz 110-120 Vac 50/60 Hz	24 V ac/dc
	4 W	1 W
	  2/sec.	  2/sec.
	Ø 0,75 mm	

- I** Prima di procedere con l'installazione bisogna predisporre a monte dell'impianto un interruttore magneto termico o differenziale con portata massima 10A.
L'interruttore deve garantire una separazione omnipolare dei contatti, con distanza di apertura di almeno 3 mm.
- UK** Before proceeding with installation, fit a magnetothermal or differential switch with a maximum capacity of 10A upstream of the system.
The switch must guarantee omnipolar separation of the contacts with an opening distance of at least 3 mm.
- F** Avant d'effectuer la mise en place, il faut prévoir en amont de l'installation un interrupteur magnétique et thermique ou différentiel ayant une capacité maximum de 10A.
L'interrupteur doit assurer une séparation omnipolaire des contacts, avec une distance d'ouverture d'au moins 3 mm.
- E** Antes de proceder con la instalación, hay que preparar aguas arriba de la instalación un interruptor térmico o diferencial con capacidad máxima de 10A.
El interruptor debe garantizar la separación omnipolar de los contactos con una distancia de apertura mínima de 3 mm.
- D** Bevor die Installation in Angriff genommen wird, ist vor der Anlage ein bei max. 10A ansprechender Thermomagnet - oder Differentialschalter zu installieren.
Der Schalter muss die allpolige Trennung der Kontakte mit einer Öffnungsweite von mindestens 3 mm garantieren.
- P** Antes de proceder com a instalação é necessário predispor a montante do sistema um interruptor magneto-térmico ou diferencial com capacidade máxima de 10A.
O interruptor deve garantir uma separação omnipolar dos contactos, com distância de abertura de, pelo menos, 3 mm.
- NL** Alvorens met de installatie te beginnen, moet u een thermomagnetische schakelaar of een differentiaalschakelaar met een maximale stroomsterkte van 10A stroomopwaarts van de installatie plaatsen.
De schakelaar moet een omnipolaire onderbreking van de contacten waarborgen, met openingsafstand van minstens 3 mm.
- GR** Πριν προχωρήσετε με την εγκατάσταση, τοποθέτηση η magnetothermal διακοπτή διαφορικού, με μεγίστη 10Α αναντή της ικανότητας του συστήματος. Ο διακοπτής πρέπει να εγγυώνται omnipolar διαχωρισμό των επαφών με ένα ανοίγμα απόσταση τουλάχιστον 3 mm.

I Grazie per avere scelto GIBIDI.**LEGGERE ATTENTAMENTE QUESTO MANUALE PRIMA DI PROCEDERE ALL'INSTALLAZIONE.**

AVVERTENZE: Questo prodotto è stato collaudato in G.I.B.I.D.I. verificando la perfetta corrispondenza delle caratteristiche alle direttive vigenti. **G.I.B.I.D.I. S.r.l. dichiara** che i prodotti, a cui questo libretto fa riferimento, sono conformi ai requisiti essenziali delle DIRETTIVE EMC 2004/108/CE e LVD 2006/95/CE. La dichiarazione completa è disponibile sul sito www.gibidi.com

SMALTIMENTO: G.I.B.I.D.I. consiglia di riciclare i componenti in plastica e di smaltire in appositi centri abilitati i componenti elettronici evitando di contaminare l'ambiente con sostanze inquinanti.

**UK** Thank you for choosing G.I.B.I.D.I.**PLEASE READ CAREFULLY THIS MANUAL BEFORE PROCEEDING WITH THE INSTALLATION.**

WARNINGS: This product has been tested in G.I.B.I.D.I. verifying the perfect correspondence of the characteristics to the current directive. **G.I.B.I.D.I. S.r.l. declares** that the products to which this handbook refers comply with the essential requirements of the following DIRECTIVES EMC 2004/108/CE - LVD 2006/95/CE. The entire declaration is available at www.gibidi.com.

DISPOSAL: G.I.B.I.D.I. advises recycling the plastic components and to dispose of them at special authorised centres for electronic components thus protecting the environment from polluting substances.

**F** Merci d'avoir choisi G.I.B.I.D.I.**NOUS VOUS PRIONS DE BIEN VOULOIR LIRE ATTENTIVEMENT CE MANUEL AVANT DE PROCÉDER À L'INSTALLATION.**

AVERTISSEMENT: Ce produit a été testé chez G.I.B.I.D.I. afin de contrôler la correspondance parfaite des caractéristiques avec les règles en vigueur. **G.I.B.I.D.I. S.r.l. déclare** que les produits, auxquels se réfère la notice, sont conformes aux conditions essentielles requises par les DIRECTIVES suivantes EMC 2004/108/CE - LVD 2006/95/CE. La déclaration complète est disponible sur le site www.gibidi.com.

ÉLIMINATION : G.I.B.I.D.I. conseille de recycler les composants en plastique et de remettre les composants électroniques à des centres spécialisés pour éviter de polluer l'environnement avec des substances polluantes.

**E** Gracias por haber elegido G.I.B.I.D.I.**POR FAVOR LEER CON ATENCIÓN ESTE MANUAL ANTES DE PROCEDER CON LA INSTALACIÓN.**

ADVERTENCIAS: Este producto ha sido ensayado en G.I.B.I.D.I. averiguando la perfecta correspondencia de las características a las normas vigentes. **G.I.B.I.D.I. S.r.l. declara** que los productos referidos en este folleto cumplen con los requisitos esenciales de las DIRECTIVAS siguientes EMC 2004/108/CE - LVD 2006/95/CE. La declaración completa está disponible en el sitio de internet www.gibidi.com.

ELIMINACION: G.I.B.I.D.I. aconseja reciclar los componentes de plástico y llevar los componentes electrónicos a los centros de recogida correspondientes evitando de esta manera la contaminación ambiental con sustancias perjudiciales.

**D** Vielen Dank, dass Sie sich für G.I.B.I.D.I. entschieden haben.**BITTE LESEN SIE VORSICHTIG DIESEN MANUALBEVOR MIT DER ANLAGE VORZUGEHEN.**

WARNUNGEN: Dieses Produkt wurde in G.I.B.I.D.I. geprüft um die perfekte Entsprechung der merkmale an die geltende vorschriften zu prüfen. **G.I.B.I.D.I. S.r.l. erklärt**, dass die Produkte, auf die sich dieses Handbuch bezieht, den grundlegenden Ansprüchen der folgenden RICHTLINIEN entsprechen EMC 2004/108/CE - LVD 2006/95/CE. Die vollständige Erklärung steht auf der Internetseite www.gibidi.com zur Verfügung.

ENTSORGUNG: G.I.B.I.D.I. empfiehlt, Kunststoffkomponenten dem Recycling zuzuführen und elektronische Komponenten in behördlich genehmigten Zentren zu entsorgen, um die Verschmutzung der Umwelt durch Schadstoffe zu verhindern.

**P** Obrigado por ter escolhido a G.I.B.I.D.I.**LER COM ATENÇÃO ESTE MANUAL ANTES DE PROCEDER COM A INSTALAÇÃO.**

ADVERTÊNCIA: Este produto foi testado em G.I.B.I.D.I. verificando a correspondência perfeita das características ao normas vigentes. **A G.I.B.I.D.I. S.r.l. declara** que os produtos referidos neste manual estão em conformidade com os requisitos essenciais das seguintes DIRECTIVAS EMC 2004/108/CE - LVD 2006/95/CE. A declaração completa está disponível no site www.gibidi.com.

ELIMINAÇÃO: G.I.B.I.D.I. aconselha a reciclar as componentes em plástico e a eliminar as componentes electrónicas em centros habilitados evitando desta forma poluir o ambiente com substâncias poluentes.

**NL** Dank u voor uw keuze van G.I.B.I.D.I.**LEES DEZE GEBRUIKSAANWIJZING ZEERAANDACHTIG ALVORENS DE INSTALLATIE AAN TE VATTEN.**

WAARSCHUWINGEN: Dit product werd gekeurd in G.I.B.I.D.I. Er werd nauwlettend gecontroleerd of de kenmerken van het product perfect overeenkomen met de geldige richtlijnen.

G.I.B.I.D.I. S.r.l. verklaart dat de producten waarop dit boekje betrekking heeft, voldoen aan de essentiële vereisten van de volgende RICHTLIJNEN EMC 2004/108/CE - LVD 2006/95/CE. De complete verklaring is beschikbaar op de site www.gibidi.com.

VERWERKING: G.I.B.I.D.I. adviseert om de kunststof componenten te recycleren en de elektronische componenten af te voeren naar erkende inzamelpunten, om te voorkomen dat het milieu verontreinigd wordt door vervuilende stoffen.

**GR** Ευχαριστούμε που επιλέξατε τα προϊόντα G.I.B.I.D.I.**ΠΑΡΑΚΑΛΟΥΜΕ ΝΑ ΔΙΑΒΑΣΤΕ ΠΡΟΣΕΚΤΙΚΑ ΑΥΤΕΣ ΤΙΣ ΟΔΗΓΙΕΣ ΠΡΙΝ ΤΗΝ ΕΓΚΑΤΑΣΤΑΣΗ**

ΣΗΜΕΙΩΣΗ: Η εταιρία G.I.B.I.D.I. έχει ελέγξει αυτό το προϊόν όσον αφορά την τέλεια προσαρμογή των χαρακτηριστικών του στην ισχύουσα νομοθεσία. Η εταιρία **G.I.B.I.D.I. S.r.l. δηλώνει** ότι τα προϊόντα στα οποία αναφέρεται αυτό το εγχειρίδιο συμμορφώνονται πλήρως με τις ουσιαστικές απαιτήσεις των οδηγιών της Ε.Ε.: EMC 2004/108/CE - LVD 2006/95/CE. Ολόκληρη η δήλωση είναι διαθέσιμη στην ιστοσελίδα: www.gibidi.com

ΔΙΑΘΕΣΗ: Η G.I.B.I.D.I. σας συμβουλεύει να ανακυκλώσετε τα πλαστικά εξαρτήματα και να διαθέσετε τα ηλεκτρονικά εξαρτήματα μετά την αποξήλωσή τους, σε εξειδικευμένα κέντρα που υπάρχουν για τον σκοπό αυτό, συμβάλλοντας έτσι στην προστασία του περιβάλλοντος από τις παρενέργειες της μόλυνσης.



GIBIDI

G.I.B.I.D.I. S.r.l.

Via Abetone Brennero, 177/B
46025 Poggio Rusco (MN) - ITALY
Tel. +39.0386.52.20.11
Fax +39.0386.52.20.31
E-mail: info@gibidi.com

Numero Verde: 800.290156

www.gibidi.com

